

New AquaMaster Shower Chair







New to our Paediatric range, we are proud to introduce the popular AquaMaster shower commmode chair, re-designed specifically for paediatric use.

Both self and attendant propelled paediatric models are now available as part of the standard range.

The chair has been designed to allow simple specification amendment to meet the changing needs of children.

Interchangeable wheels, seats, armrests, backrests, footrests and accessories make the chair ideal for loan store use.

Features

-  Sturdy one piece frame
-  Durable powder coated finish
-  15" standard seat width
-  12" standard seat depth
-  Flat padded, aperture and horseshoe seat options
-  20", 22" & 24" self propelling wheels size option



A21 Self propelled



A20 Attendant propelled

-  Convertable between self and attendant propelled*
-  Optional full height backrest fabric
-  Large range of accessories including;
 -  Side pads
 -  Thoracic supports
 -  Harnesses
 -  Head supports
 -  Foot trays
-  Custom made chairs and accessories available
-  Available in over 150 frame colour options, included in standard price. Standard colour is white. (please contact us for a colour chart)
-  Survey and demonstration visits on request

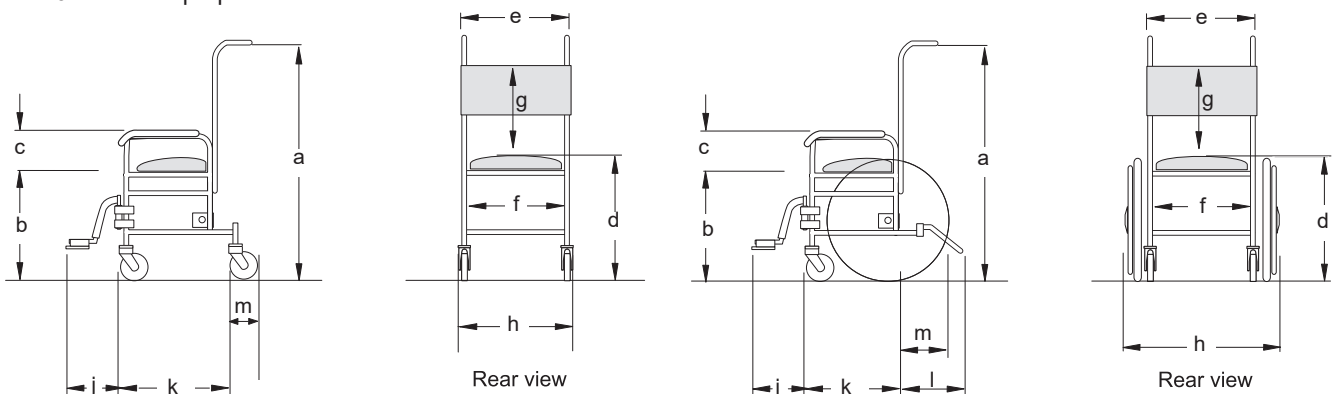

	a	b	c	d	e	f	g	h	j	k	l	m
A20	940	480	220	490	400	350	420	580	270	430	N/A	125
A21	940	480	220	490	400	350	420	580	270	430	250**	215

* Conversion requirements
Self propelled to Attendant propelled
Four braked castors

Attendant propelled to Self propelled
Self propelling wheels, wheel brakes, anti tip bars

**based on 22" wheel