

SHOWER CUBICLE SELECTOR -FRONT ENTRY CUBICLES

Use this shower tray selector to choose the cubicle base size required.

FRONT ENTRY 100MK2 SHOWER CUBICLE

Ramp size
780mm Width x
200mm Depth

**Model 100MK2
(Standard doors)**

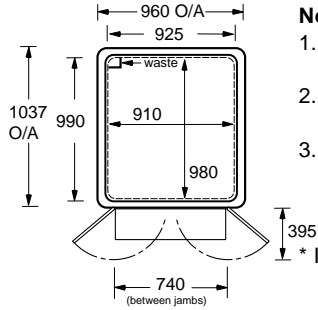

See page 114 for technical information and details of How to order

Notes:

1. Add 50mm at rear of cubicle to allow for waste hose*
2. Add 100mm to width to allow for shower unit services
3. Allow as much space as possible to gain access to services for routine maintenance.

* If pumped version

**Model 100MK2
(Tri-fold doors)**

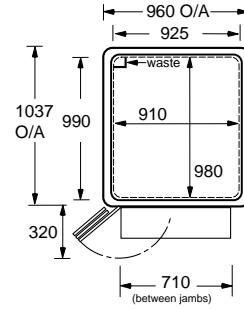

Note:
Left hand trifold illustrated. Right hand version available.

FRONT ENTRY SHOWER CUBICLE - MODEL 75

Ramp size
775mm Width x
220mm Depth

**Model 75
(Standard doors)**

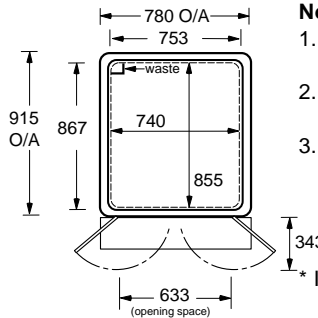

See page 115 for technical information and details of How to order

Notes:

1. Add 50mm at rear of cubicle to allow for waste hose*
2. Add 100mm to width to allow for shower unit services
3. Allow as much space as possible to gain access to services for routine maintenance.

* If pumped version

Model 75 (Tri-fold doors)

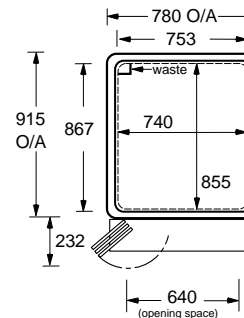

Note:
Left hand trifold illustrated. Right hand version available.

FRONT ENTRY SHOWER CUBICLE - MODEL 101

Ramp size
1000mm Width x
430mm Depth

**Model 101
(Standard doors)**

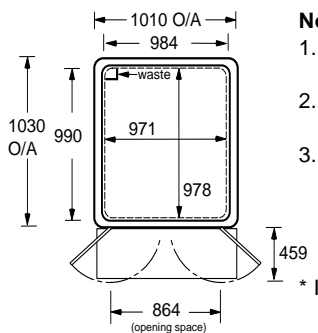

See page 116 for technical information and details of How to order

Notes:

1. Add 50mm at rear of cubicle to allow for waste hose*
2. Add 100mm to width to allow for shower unit services
3. Allow as much space as possible to gain access to services for routine maintenance.

* If pumped version

**Model 101
(Tri-fold doors)**

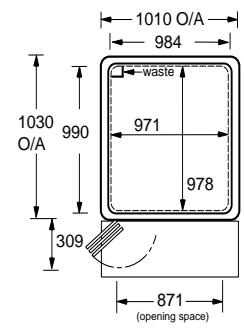

Note:
Left hand trifold illustrated. Right hand version available.

FRONT ENTRY SHOWER CUBICLE - MODEL 120

Ramp size
890mm Width x
220mm Depth

**Model 120
(Standard doors)**

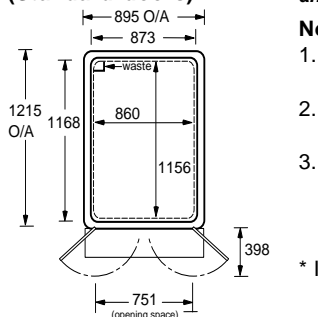

See page 117 for technical information and details of How to order

Notes:

1. Add 50mm at rear of cubicle to allow for waste hose*
2. Add 100mm to width to allow for shower unit services
3. Allow as much space as possible to gain access to services for routine maintenance.

* If pumped version

**Model 120
(Tri-fold doors)**

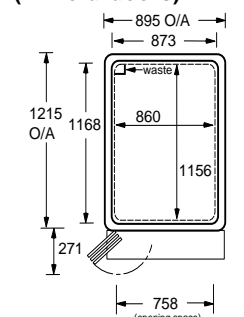

Note:
Left hand trifold illustrated. Right hand version available.

SYMBOLS:

Bulk/oversized item



Made to order (see P200)



Tel: 0800 917 0399

www.chilterninvadex.co.uk

Fax: +44 (0) 1869 365588

sales@chilterninvadex.co.uk

SHOWER CUBICLE SELECTOR -FRONT ENTRY TOILET CUBICLES

Use this shower tray selector to choose the cubicle base size required.

FRONT ENTRY 100MK2 SHOWER TOILET CUBICLE

Model 100MK2 (Standard doors)

Ramp size
780mm Width x
200mm Depth

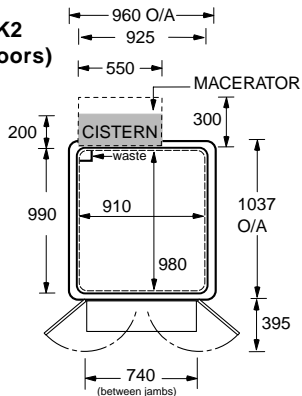

See page 122 for technical information and details of How to order

Notes:

1. Add 50mm at rear of cubicle to allow for waste hose*
2. Add 100mm to width to allow for shower unit services
3. Allow as much space as possible to gain access to services for routine maintenance.

* If pumped version

Model 100MK2 (Tri-fold doors)

Note:

Left hand trifold illustrated. Right hand version available.

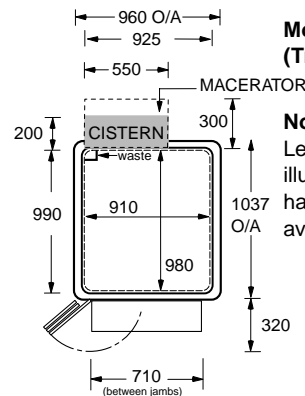

FRONT ENTRY SHOWER TOILET CUBICLE - MODEL 75

Model 75 (Standard doors)

Ramp size
775mm Width x
220mm Depth

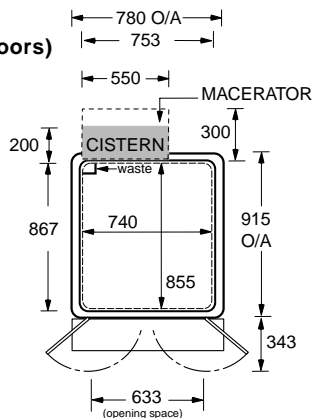

See page 123 for technical information and details of How to order

Notes:

1. Add 50mm at rear of cubicle to allow for waste hose*
2. Add 100mm to width to allow for shower unit services
3. Allow as much space as possible to gain access to services for routine maintenance.

* If pumped version

Model 75 (Tri-fold doors)

Note:

Left hand trifold illustrated. Right hand version available.

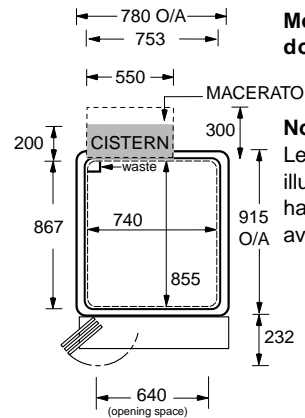

FRONT ENTRY SHOWER TOILET CUBICLE - MODEL 101

Model 101 (Standard doors)

Ramp size
1000mm Width x
430mm Depth

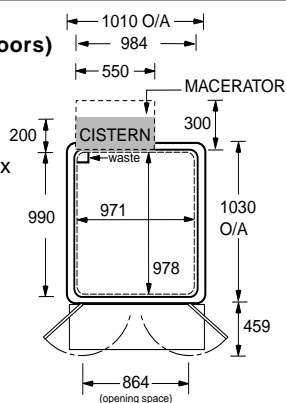

See page 124 for technical information and details of How to order

Notes:

1. Add 50mm at rear of cubicle to allow for waste hose*
2. Add 100mm to width to allow for shower unit services
3. Allow as much space as possible to gain access to services for routine maintenance.

* If pumped version

Model 101 (Tri-fold doors)

Note:

Left hand trifold illustrated. Right hand version available.

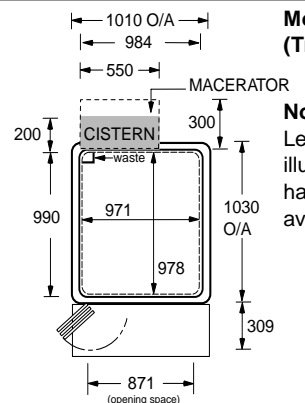

FRONT ENTRY SHOWER TOILET CUBICLE - MODEL 120

Model 120 (Standard doors)

Ramp size
890mm Width x
220mm Depth

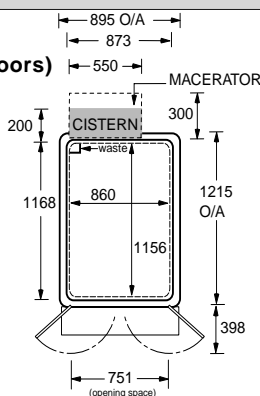

See page 125 for technical information and details of How to order

Notes:

1. Add 50mm at rear of cubicle to allow for waste hose*
2. Add 100mm to width to allow for shower unit services
3. Allow as much space as possible to gain access to services for routine maintenance.

* If pumped version

Model 120 (Tri-fold doors)

Note:

Left hand trifold illustrated. Right hand version available.

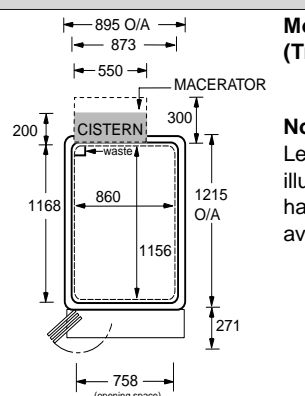

SYMBOLS:

Bulk/oversized item



Made to order (see P200)



Tel: 0800 917 0399

www.chilterninvadex.co.uk

Fax: +44 (0) 1869 365588

sales@chilterninvadex.co.uk

SHOWER CUBICLE SELECTOR - SIDE ENTRY CUBICLES

Use this shower tray selector to choose the cubicle base size required.

SIDE ENTRY MK2 SHOWER CUBICLE

SIDE ENTRY MK2 (Standard doors)

Ramp size
1025mm Width x
250mm Depth

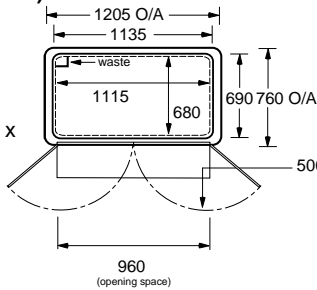

See page 118 for technical information
and details of How to order

Notes:

1. Add 50mm at rear of cubicle to allow for waste hose*
2. Add 100mm to width to allow for shower unit services
3. Allow as much space as possible to gain access to services for routine maintenance.

* If pumped version

SIDE ENTRY MK2 (Tri-fold doors)

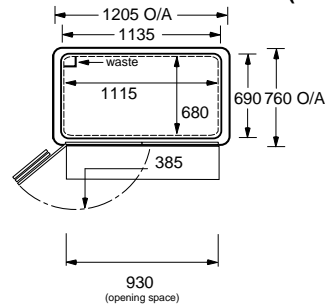

Note:

Left hand trifold illustrated. Right hand version available.

SLIMLINE SIDE ENTRY SHOWER CUBICLE

Slimline Side Entry (Standard doors)

Ramp size
900mm Width x
220mm Depth

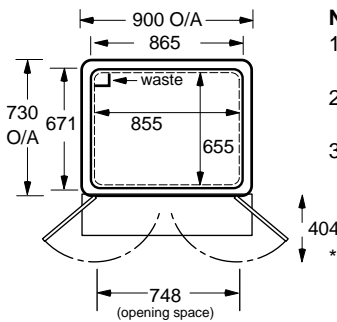

See page 119 for technical information
and details of How to order

Notes:

1. Add 50mm at rear of cubicle to allow for waste hose*
2. Add 100mm to width to allow for shower unit services
3. Allow as much space as possible to gain access to services for routine maintenance.

* If pumped version

Slimline Side Entry (Tri-fold doors)

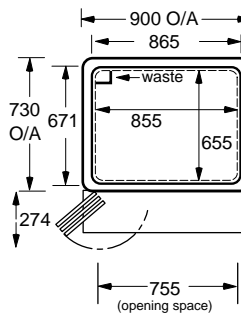

Note:

Left hand trifold illustrated. Right hand version available.

SHOWER CUBICLE SELECTOR - CORNER CUBICLE

CORNER CUBICLE

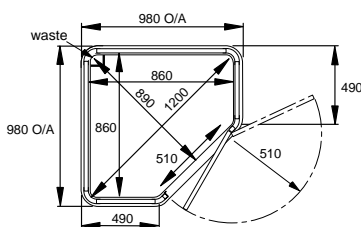

Notes:

1. Add 50mm at rear of cubicle to allow for waste hose
2. Add 100mm to width to allow for shower unit services
3. Allow as much space as possible to gain access to services for routine maintenance.

Note:

Right hand door illustrated. Left hand version available. Half, stable and full height options also available.

See page 120 for technical information
and details of How to order

SYMBOLS:

Bulk/oversized item



Made to order (see P200)



Tel: 0800 917 0399

www.chilterninvadex.co.uk

Fax: +44 (0) 1869 365588

sales@chilterninvadex.co.uk

SHOWER CUBICLE SELECTOR - SIDE ENTRY TOILET CUBICLES

Use this shower tray selector to choose the cubicle base size required.

SIDE ENTRY MK2 SHOWER TOILET CUBICLE

SIDE ENTRY MK2 (Standard doors)

SIDE ENTRY MK2 (Tri-fold doors)

See page 126 for technical information and details of How to order

Notes:

1. Add 50mm at rear of cubicle to allow for waste hose*
2. Add 100mm to width to allow for shower unit services
3. Allow as much space as possible to gain access to services for routine maintenance.

* If pumped version

Note:
Left hand trifold illustrated. Right hand version available.

SHOWER CHAIR CUBICLE COMPATIBILITY

CUBICLE MODEL	AQUAMASTER SHOWER CHAIR MODEL				TRANSAQUA SHOWER CHAIR MODEL					
	A02	A06	A08	A11	TA18AP	TA21AP	TA18SP	TA21SP	TA18SP LWB	TA21SP LWB
FRONT ENTRY										
Model 75	✓*	✗*	✗*	✗*	✗*	✗*	✗*	✗*	✗*	✗*
Model 101	✓*	✓*	✓*	✗*	✓*	✓*	✗*	✗*	✗*	✗*
Model 120	✓*	✓*	✓*	✓*	✓*	✓*	✓*	✗*	✗*	✗*
Model 100MK2	✓*	✓*	✓*^	✗*	✓*	✓*	✗*	✗*	✗*	✗*
SIDE ENTRY										
Side Entry MK2	✓*	✗*	✗*	✗*	✗*	✗*	✗*	✗*	✗*	✗*
Slimline Side Entry MK2	✓*	✗*	✗*	✗*	✗*	✗*	✗*	✗*	✗*	✗*
CORNER CUBICLE										
Corner Cubicle	✗*	✗*	✗*	✗*	✗*	✗*	✗*	✗*	✗*	✗*

*See page 109 for suitable tip-up shower seat/bench seat/stool compatibility

^ 21" Model - standard door option only

LWB= Long wheel base

SHOWER CHAIR CUBICLE TOILET COMPATIBILITY

CUBICLE MODEL	AQUAMASTER SHOWER CHAIR MODEL				TRANSAQUA SHOWER CHAIR MODEL					
	A02	A06	A08	A11	TA18AP	TA21AP	TA18SP	TA21SP	TA18SP LWB	TA21SP LWB
FRONT ENTRY										
Model 75	✓	✗	✗	✗	✗	✗	✗	✗	✗	✗
Model 101	✓	✓	✓	✗	✓	✓	✗	✗	✗	✗
Model 120	✓	✓	✓	✓	✓	✓	✓	✗	✗	✗
Model 100MK2	✓	✓	✓^	✗	✓	✓	✗	✗	✗	✗
SIDE ENTRY										
Side Entry MK2	✓	✗	✗	✗	✗	✗	✗	✗	✗	✗
Slimline Side Entry MK2	No Shower cubicle toilet option									
CORNER CUBICLE										
Corner Cubicle	No Shower cubicle toilet option									

^ 21" Model - standard door option only

LWB= Long wheel base

Note: All Shower Cubicle Toilet models are **unsuitable** for tip-up shower seat/bench seat/stool compatibility

SYMBOLS:

Bulk/oversized item

Made to order (see P200)



Tel: 0800 917 0399

www.chilterninvadex.co.uk

Fax: +44 (0) 1869 365588

sales@chilterninvadex.co.uk